

IRGB5B120KDPbF

INSULATED GATE BIPOLAR TRANSISTOR WITH ULTRAFAST SOFT RECOVERY DIODE

Features

- Low VCE (on) Non Punch Through IGBT Technology.
- Low Diode VF.
- 10µs Short Circuit Capability.
- Square RBSOA.
- Ultrasoft Diode Reverse Recovery Characteristics.
- Positive VCE (on) Temperature Coefficient.
- TO-220 Package.
- Lead-Free

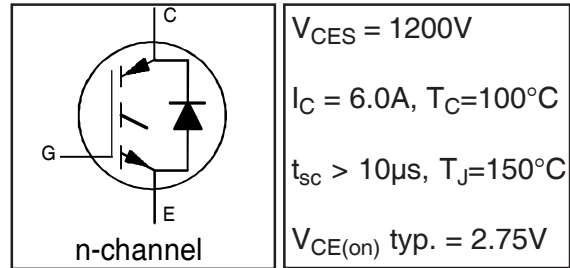

Benefits

- Benchmark Efficiency for Motor Control.
- Rugged Transient Performance.
- Low EMI.
- Excellent Current Sharing in Parallel Operation.

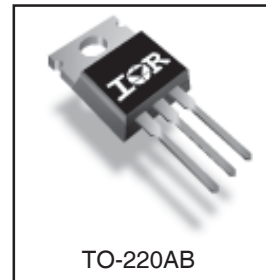

Absolute Maximum Ratings

	Parameter	Max.	Units
V_{CES}	Collector-to-Emitter Voltage	1200	V
$I_C @ T_C = 25^\circ C$	Continuous Collector Current	12	A
$I_C @ T_C = 100^\circ C$	Continuous Collector Current	6.0	
I_{CM}	Pulsed Collector Current	24	
I_{LM}	Clamped Inductive Load Current $\text{\textcircled{D}}$	24	
$I_F @ T_C = 25^\circ C$	Diode Continuous Forward Current	12	
$I_F @ T_C = 100^\circ C$	Diode Continuous Forward Current	6.0	
I_{FM}	Diode Maximum Forward Current	24	
V_{GE}	Gate-to-Emitter Voltage	± 20	V
$P_D @ T_C = 25^\circ C$	Maximum Power Dissipation	89	W
$P_D @ T_C = 100^\circ C$	Maximum Power Dissipation	36	
T_J	Operating Junction and	-55 to +150	$^\circ C$
T_{STG}	Storage Temperature Range		
	Soldering Temperature, for 10 sec.	300 (0.063 in. (1.6mm) from case)	
	Mounting Torque, 6-32 or M3 Screw.	10 lbf•in (1.1 N•m)	

Thermal Resistance

	Parameter	Min.	Typ.	Max.	Units
$R_{\theta JC}$	Junction-to-Case - IGBT	—	—	1.4	$^\circ C/W$
$R_{\theta JC}$	Junction-to-Case - Diode	—	—	2.8	
$R_{\theta CS}$	Case-to-Sink, flat, greased surface	—	0.50	—	
$R_{\theta JA}$	Junction-to-Ambient, typical socket mount	—	—	62	
Wt	Weight	—	2 (0.07)	—	g (oz)

IRGB5B120KDPbF

International
IR Rectifier

Electrical Characteristics @ T_J = 25°C (unless otherwise specified)

	Parameter	Min.	Typ.	Max.	Units	Conditions	Ref.Fig.
V _{(BR)CES}	Collector-to-Emitter Breakdown Voltage	1200	—	—	V	V _{GE} = 0V, I _C = 500μA	
ΔV _{(BR)CES/ΔT_J}	Temperature Coeff. of Breakdown Voltage	—	1.15	—	V/°C	V _{GE} = 0V, I _C = 1.0mA, (25°C-125°C)	
V _{CE(on)}	Collector-to-Emitter Saturation Voltage	—	2.75	3.0	V	I _C = 6.0A V _{GE} = 15V	5, 6, 7
		—	3.36	3.7		I _C = 6.0A V _{GE} = 15V T _J = 125°C	9,10,11
V _{GE(th)}	Gate Threshold Voltage	4.0	5.0	6.0	V	V _{CE} = V _{GE} , I _C = 250μA	9,10,11
ΔV _{GE(th)/ΔT_J}	Temperature Coeff. of Threshold Voltage	—	-11	—	mV/°C	V _{CE} = V _{GE} , I _C = 1.0mA, (25°C-125°C)	12
g _{fe}	Forward Transconductance	—	2.6	—	S	V _{CE} = 50V, I _C = 6.0A, PW=80μs	
I _{CES}	Zero Gate Voltage Collector Current	—	—	100	μA	V _{GE} = 0V, V _{CE} = 1200V	
		—	66	200		V _{GE} = 0V, V _{CE} = 1200V, T _J = 125°C	
V _{FM}	Diode Forward Voltage Drop	—	2.13	2.45	V	I _F = 6.0A	8
		—	2.38	2.75		I _F = 6.0A T _J = 125°C	
I _{GES}	Gate-to-Emitter Leakage Current	—	—	±100	nA	V _{GE} = ±20V	

Switching Characteristics @ T_J = 25°C (unless otherwise specified)

	Parameter	Min.	Typ.	Max.	Units	Conditions	Ref.Fig.
Q _g	Total Gate Charge (turn-on)	—	25	38	nC	I _C = 6.0A	23
Q _{ge}	Gate - Emitter Charge (turn-on)	—	3.7	5.6		V _{CC} = 800V	CT1
Q _{gc}	Gate - Collector Charge (turn-on)	—	13	20		V _{GE} = 15V	
E _{on}	Turn-On Switching Loss	—	390	440	μJ	I _C = 6.0A, V _{CC} = 600V	CT4
E _{off}	Turn-Off Switching Loss	—	330	440		V _{GE} = 15V, R _G = 50Ω, L = 3.7mH	
E _{tot}	Total Switching Loss	—	720	880		L _s = 150nH T _J = 25°C ⊙	
t _{d(on)}	Turn-On Delay Time	—	22	29	ns	I _C = 6.0A, V _{CC} = 600V	CT4
t _r	Rise Time	—	19	27		V _{GE} = 15V, R _G = 50Ω L = 3.7mH	
t _{d(off)}	Turn-Off Delay Time	—	100	120		L _s = 150nH, T _J = 25°C	
t _f	Fall Time	—	19	25			
E _{on}	Turn-On Switching Loss	—	440	660	μJ	I _C = 6.0A, V _{CC} = 600V	CT4
E _{off}	Turn-Off Switching Loss	—	370	560		V _{GE} = 15V, R _G = 50Ω, L = 3.7mH	13,15
E _{tot}	Total Switching Loss	—	810	1220		L _s = 150nH T _J = 125°C ⊙	WF1,WF2
t _{d(on)}	Turn-On Delay Time	—	21	27	ns	I _C = 6.0A, V _{CC} = 600V	14, 16
t _r	Rise Time	—	18	25		V _{GE} = 15V, R _G = 50Ω L = 3.7mH	CT4
t _{d(off)}	Turn-Off Delay Time	—	110	150		L _s = 150nH, T _J = 125°C	WF1
t _f	Fall Time	—	22	29			WF2
C _{ies}	Input Capacitance	—	370	—	pF	V _{GE} = 0V	22
C _{oes}	Output Capacitance	—	33	—		V _{CC} = 30V	
C _{res}	Reverse Transfer Capacitance	—	11	—		f = 1.0MHz	
RBSOA	Reverse Bias Safe Operating Area	FULL SQUARE				T _J = 150°C, I _C = 24A, V _p = 1200V V _{CC} = 1000V, V _{GE} = +15V to 0V, R _G = 50Ω	4 CT2
SCSOA	Short Circuit Safe Operating Area	10	—	—	μs	T _J = 150°C, V _p = 1200V, R _G = 50Ω V _{CC} = 900V, V _{GE} = +15V to 0V	CT3 WF4
E _{rec}	Reverse Recovery energy of the diode	—	360	—	μJ	T _J = 125°C	17,18,19
t _{rr}	Diode Reverse Recovery time	—	160	—	ns	V _{CC} = 600V, I _F = 6.0A, L = 2.0mH	20, 21
I _{rr}	Diode Peak Reverse Recovery Current	—	9.0	—	A	V _{GE} = 15V, R _G = 50Ω, L _s = 150nH	CT4,WF3

Note:

⊙ V_{CC} = 80% (V_{CES}), V_{GE} = 15V, L = 100μH, R_G = 50Ω.

⊙ Energy losses include "tail" and diode reverse recovery.

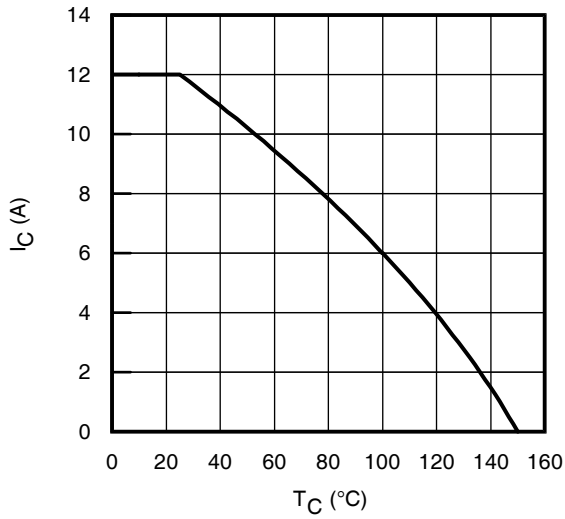

Fig. 1 - Maximum DC Collector Current vs. Case Temperature

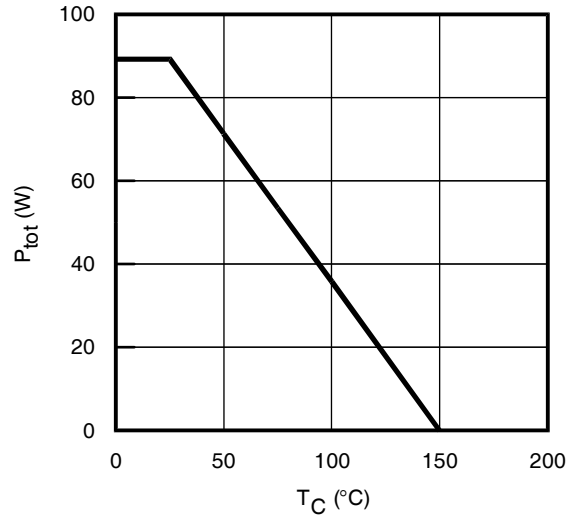

Fig. 2 - Power Dissipation vs. Case Temperature

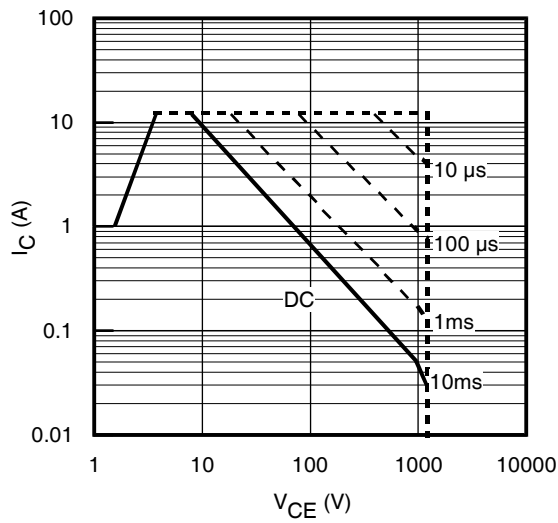

Fig. 3 - Forward SOA
 $T_C = 25^{\circ}C$; $T_J \leq 150^{\circ}C$

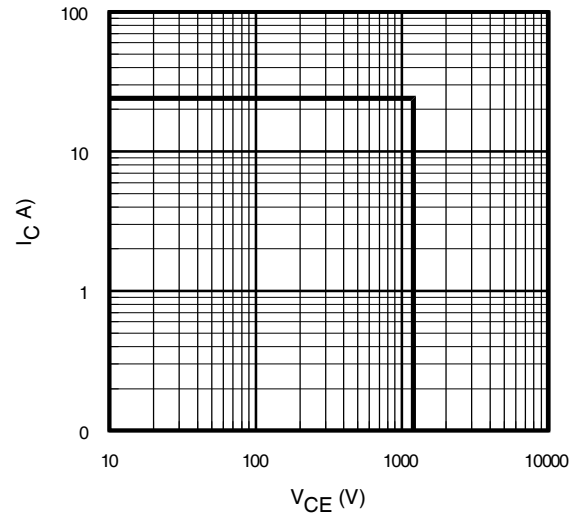

Fig. 4 - Reverse Bias SOA
 $T_J = 150^{\circ}C$; $V_{GE} = 15V$

IRGB5B120KDPbF

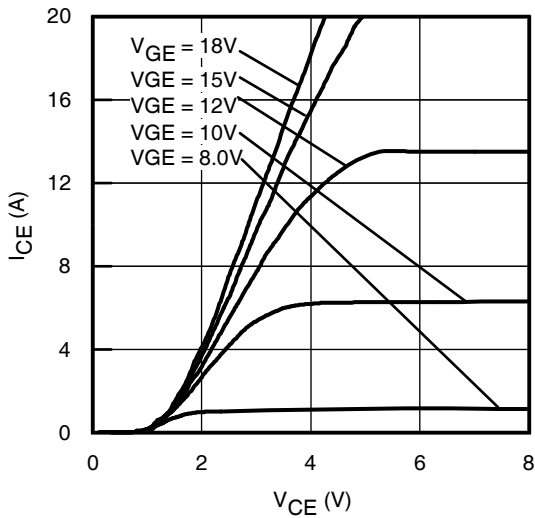

Fig. 5 - Typ. IGBT Output Characteristics
 $T_J = -40^\circ\text{C}$; $t_p = 80\mu\text{s}$

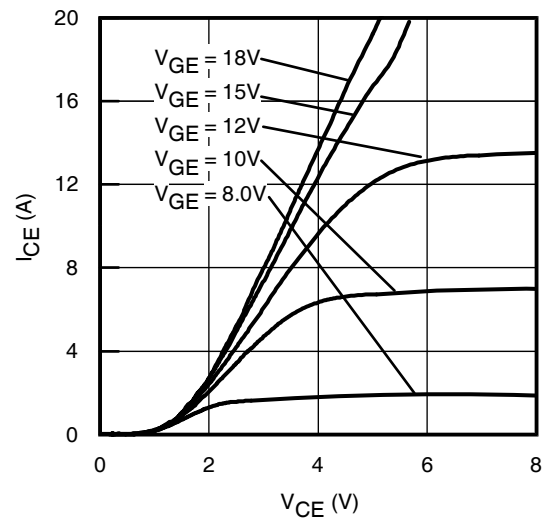

Fig. 6 - Typ. IGBT Output Characteristics
 $T_J = 25^\circ\text{C}$; $t_p = 80\mu\text{s}$

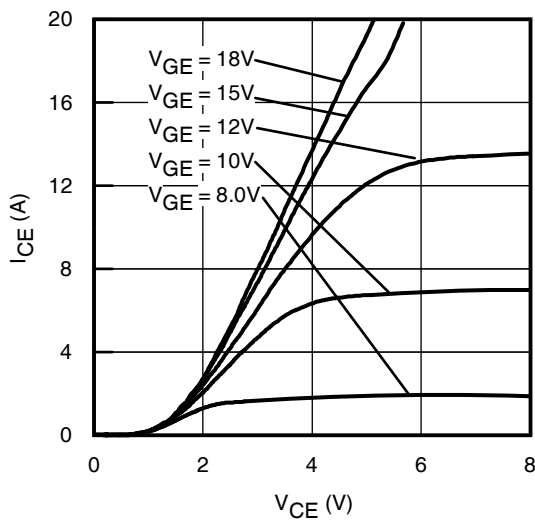

Fig. 7 - Typ. IGBT Output Characteristics
 $T_J = 125^\circ\text{C}$; $t_p = 80\mu\text{s}$

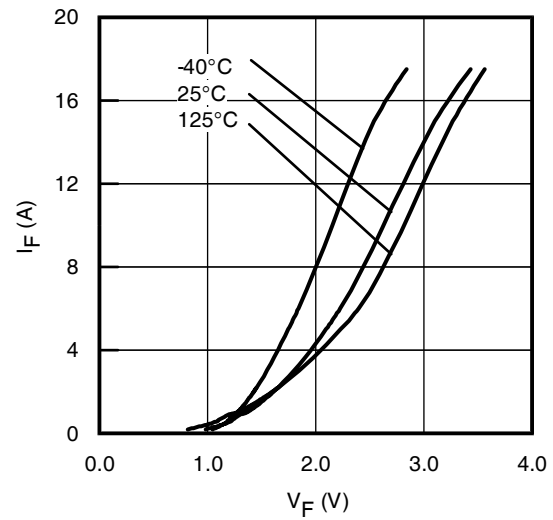

Fig. 8 - Typ. Diode Forward Characteristics
 $t_p = 80\mu\text{s}$

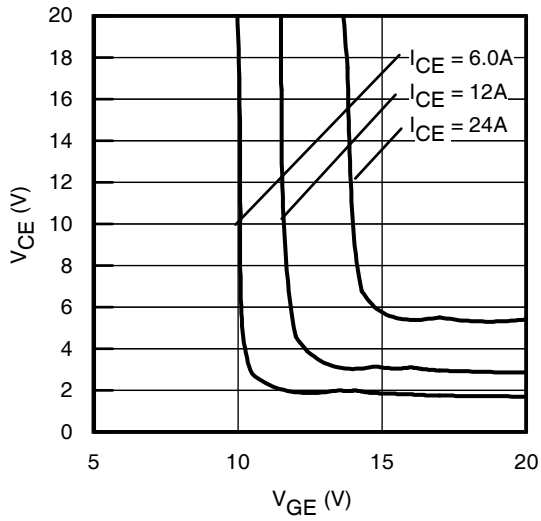

Fig. 9 - Typical V_{CE} vs. V_{GE}
 $T_J = -40^\circ\text{C}$

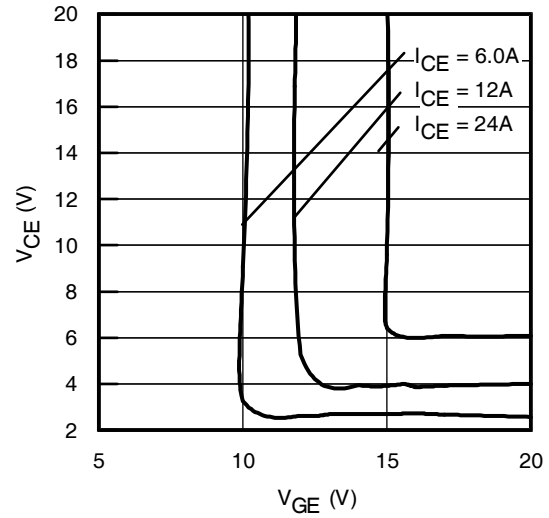

Fig. 10 - Typical V_{CE} vs. V_{GE}
 $T_J = 25^\circ\text{C}$

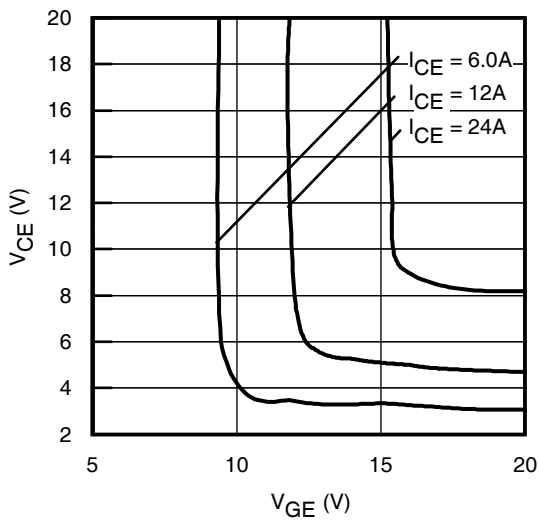

Fig. 11 - Typical V_{CE} vs. V_{GE}
 $T_J = 125^\circ\text{C}$

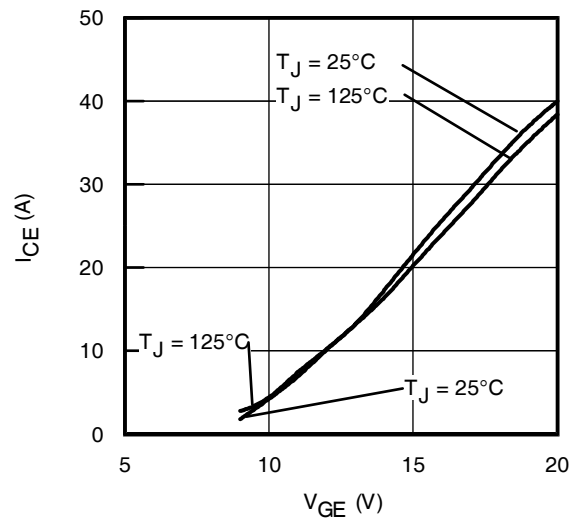

Fig. 12 - Typ. Transfer Characteristics
 $V_{CE} = 50\text{V}$; $t_p = 10\mu\text{s}$

IRGB5B120KDPbF

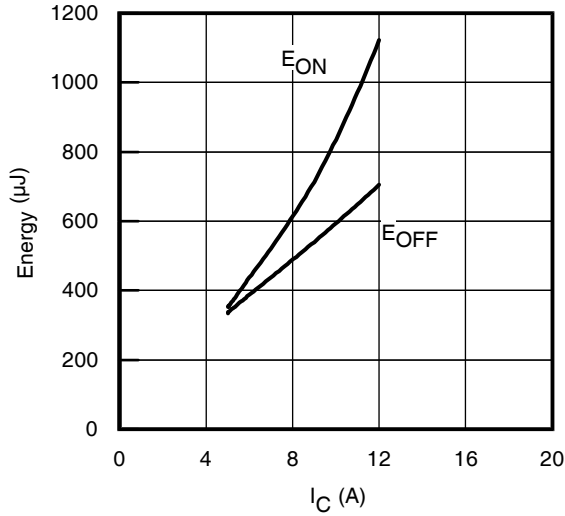

Fig. 13 - Typ. Energy Loss vs. I_C
 $T_J = 125^\circ\text{C}$; $L=3.7\text{mH}$; $V_{CE}= 600\text{V}$
 $R_G= 50\Omega$; $V_{GE}= 15\text{V}$

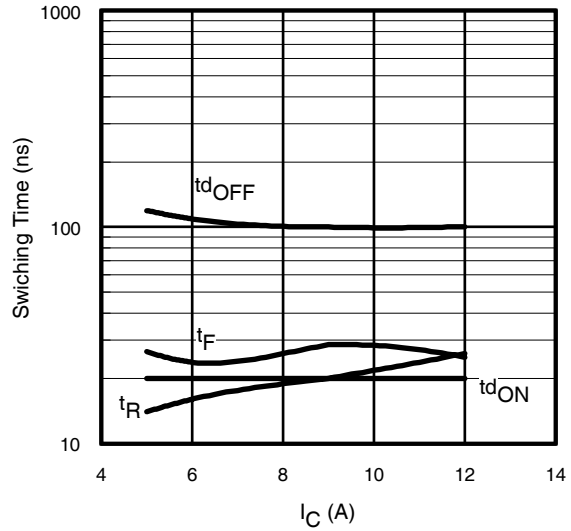

Fig. 14 - Typ. Switching Time vs. I_C
 $T_J = 125^\circ\text{C}$; $L=3.7\text{mH}$; $V_{CE}= 600\text{V}$
 $R_G= 50\Omega$; $V_{GE}= 15\text{V}$

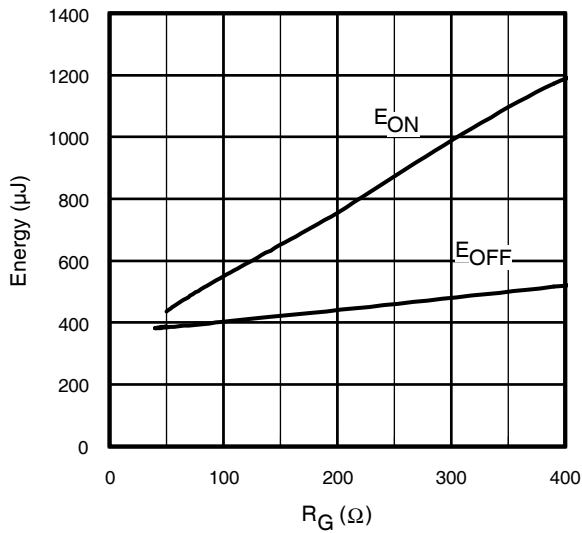

Fig. 15 - Typ. Energy Loss vs. R_G
 $T_J = 125^\circ\text{C}$; $L=3.7\text{mH}$; $V_{CE}= 600\text{V}$
 $I_{CE}= 6.0\text{A}$; $V_{GE}= 15\text{V}$

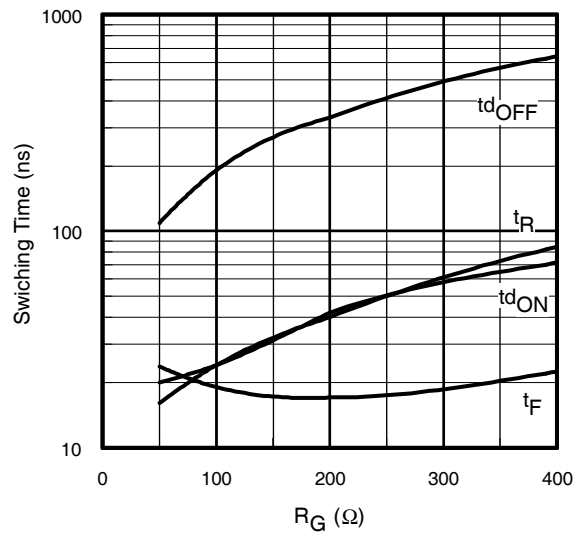

Fig. 16 - Typ. Switching Time vs. R_G
 $T_J = 125^\circ\text{C}$; $L=3.7\text{mH}$; $V_{CE}= 600\text{V}$
 $I_{CE}= 6.0\text{A}$; $V_{GE}= 15\text{V}$

IRGB5B120KDPbF

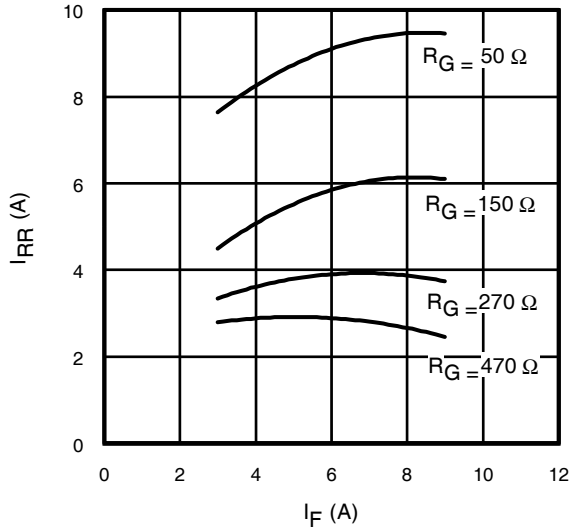

Fig. 17 - Typical Diode I_{RR} vs. I_F
 $T_J = 125^\circ\text{C}$

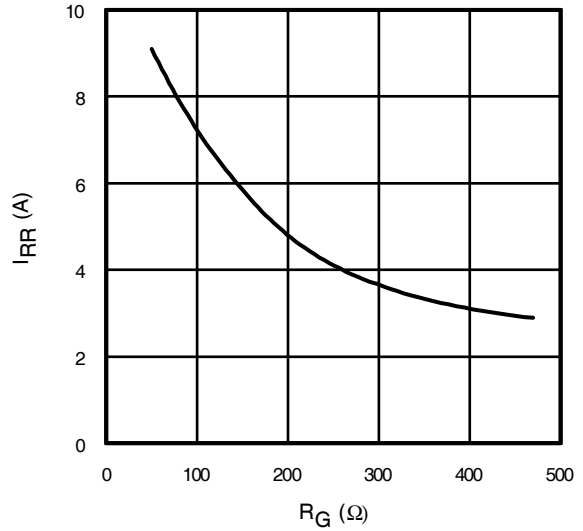

Fig. 18 - Typical Diode I_{RR} vs. R_G
 $T_J = 125^\circ\text{C}$; $I_F = 6.0\text{A}$

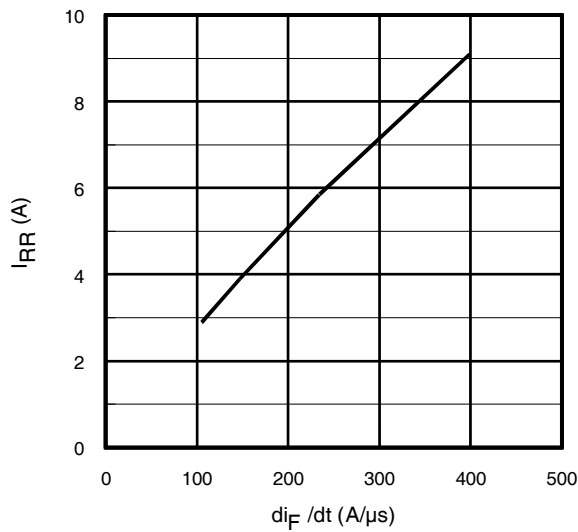

Fig. 19- Typical Diode I_{RR} vs. di_F/dt
 $V_{CC} = 600\text{V}$; $V_{GE} = 15\text{V}$;
 $I_F = 6.0\text{A}$; $T_J = 125^\circ\text{C}$

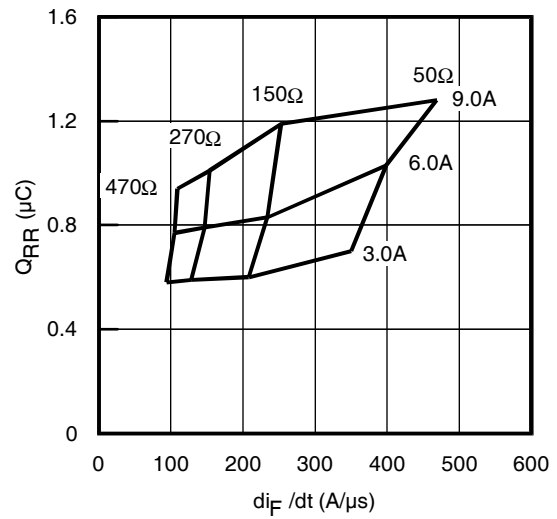

Fig. 20 - Typical Diode Q_{RR}
 $V_{CC} = 600\text{V}$; $V_{GE} = 15\text{V}$; $T_J = 125^\circ\text{C}$

IRGB5B120KDPbF

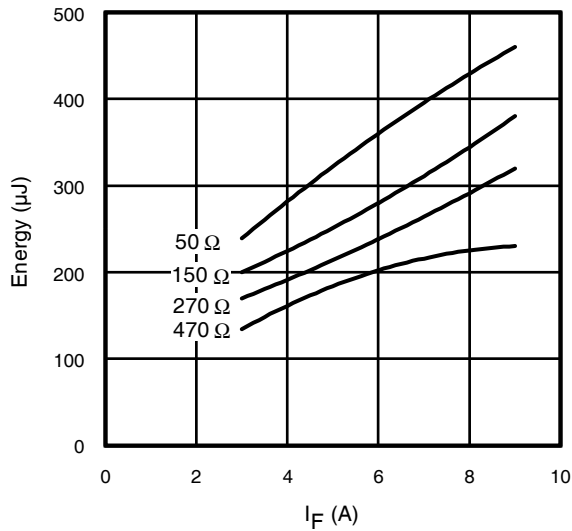

Fig. 21 - Typical Diode E_{RR} vs. I_F
 $T_J = 125^\circ\text{C}$

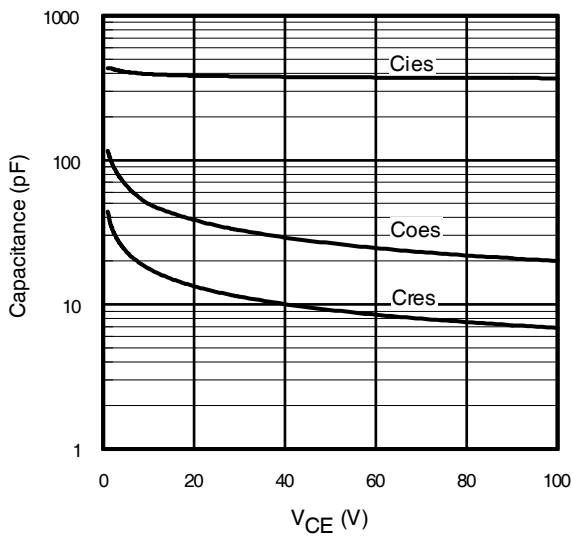

Fig. 22- Typ. Capacitance vs. V_{CE}
 $V_{GE} = 0\text{V}$; $f = 1\text{MHz}$

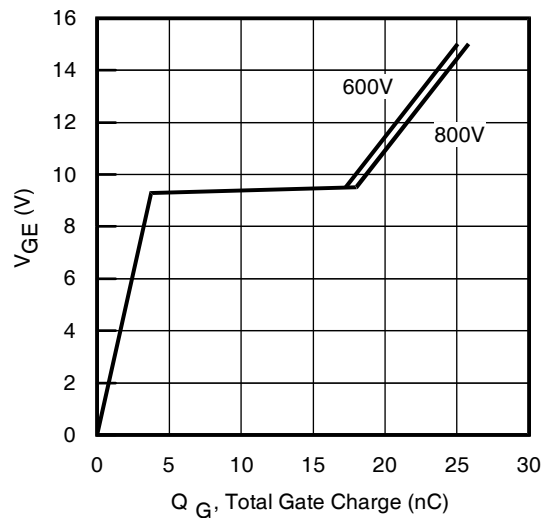

Fig. 23 - Typical Gate Charge vs. V_{GE}
 $I_{CE} = 6.0\text{A}$; $L = 600\mu\text{H}$

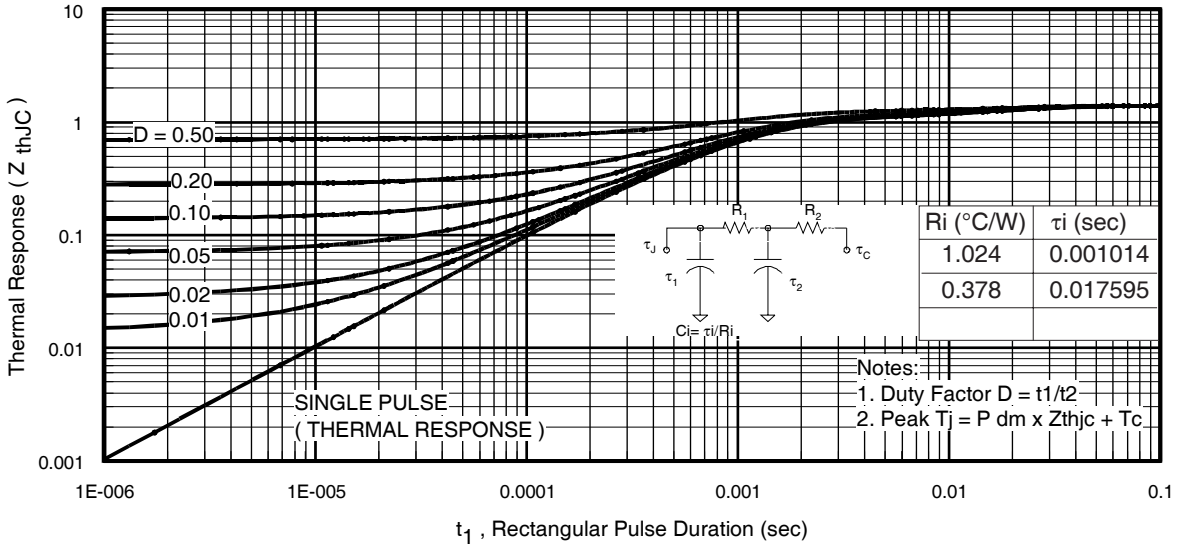

Fig 24. Maximum Transient Thermal Impedance, Junction-to-Case (IGBT)

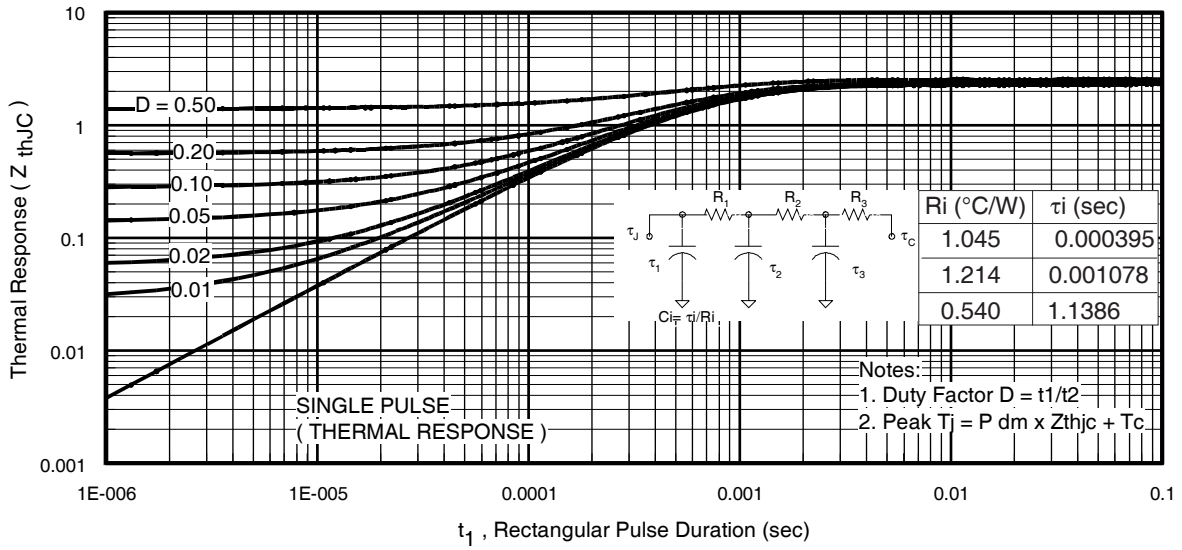

Fig 25. Maximum Transient Thermal Impedance, Junction-to-Case (DIODE)

IRGB5B120KDPbF

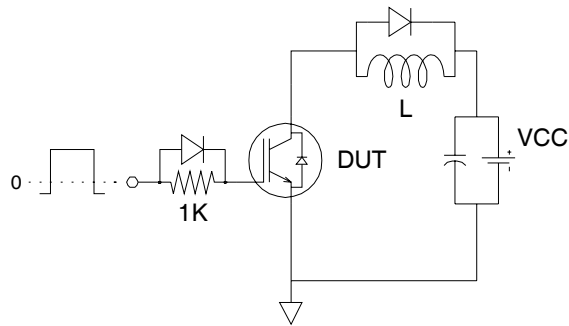

Fig.C.T.1 - Gate Charge Circuit (turn-off)

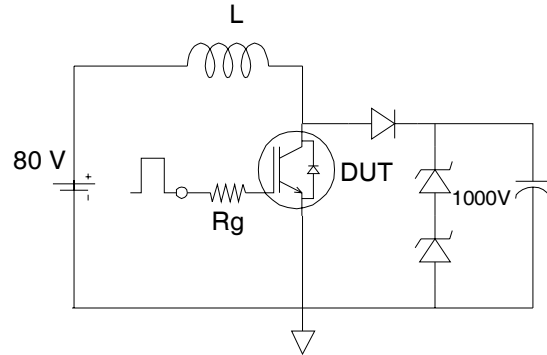

Fig.C.T.2 - RBSOA Circuit

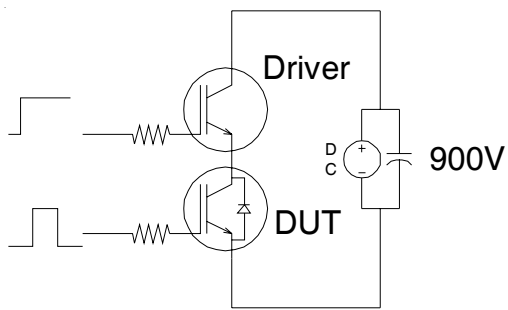

Fig.C.T.3 - S.C. SOA Circuit

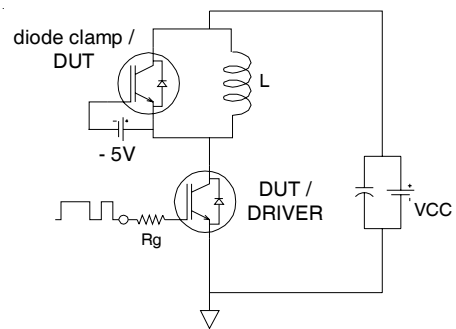

Fig.C.T.4 - Switching Loss Circuit

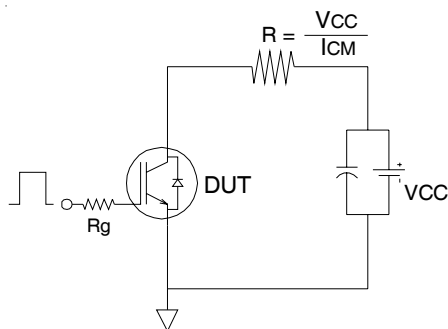

Fig.C.T.5 - Resistive Load Circuit

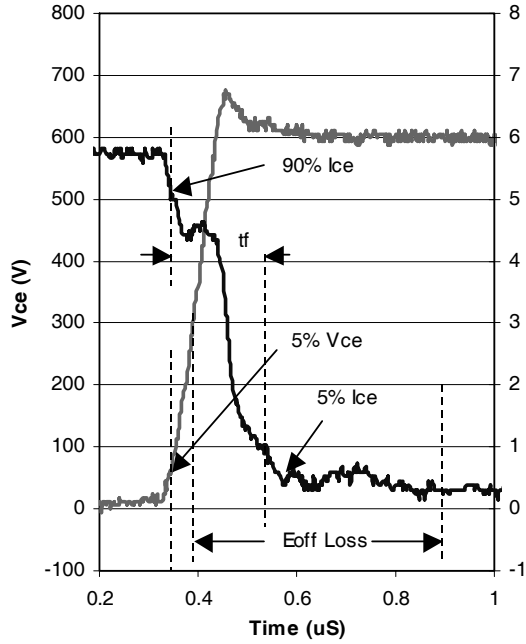

Fig.WF2-Typ. Turn-off Loss Waveform
@ $T_J = 125^\circ\text{C}$ using Fig. CT4

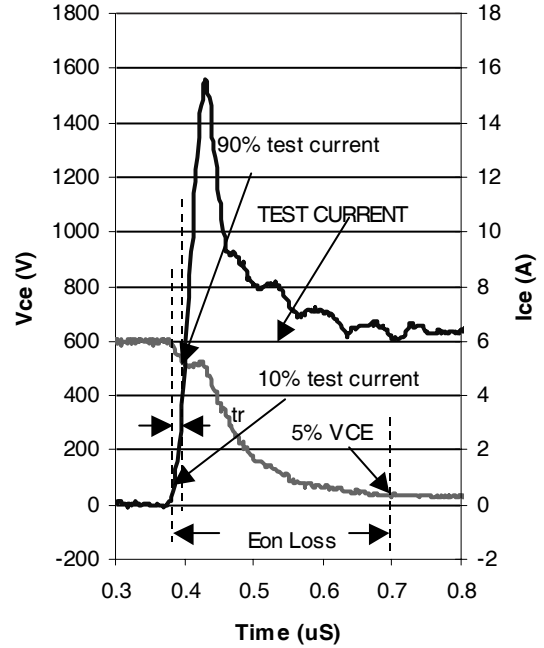

Fig.WF2-Typ. Turn-on Loss Waveform
@ $T_J = 125^\circ\text{C}$ using Fig. CT4

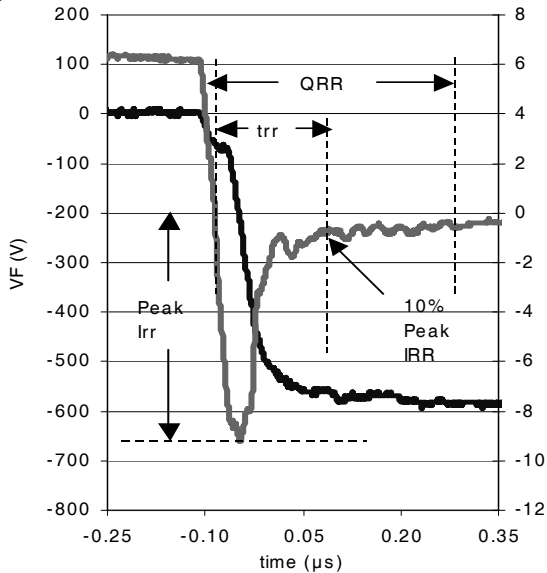

Fig.WF3-Typ. Diode Recovery Waveform
@ $T_J = 125^\circ\text{C}$ using Fig. CT4

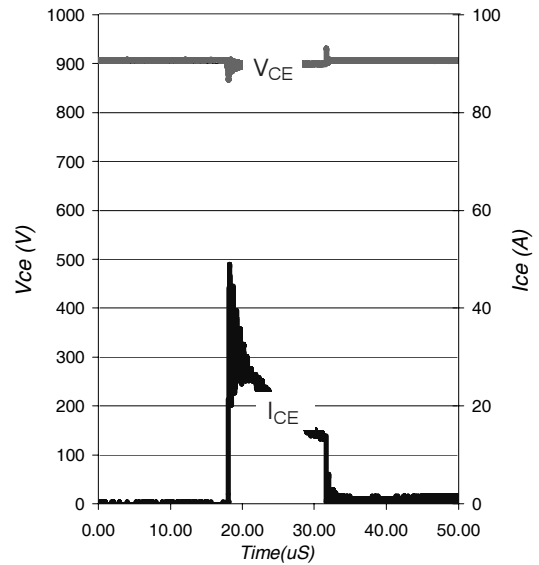

Fig.WF4-Typ. S.C. Waveform
@ $T_C = 150^\circ\text{C}$ using Fig. CT3

IRGB5B120KDPbF



TO-220AB Package Outline

Dimensions are shown in millimeters (inches)

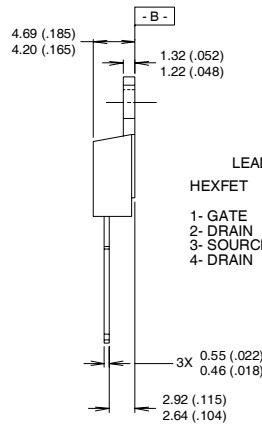
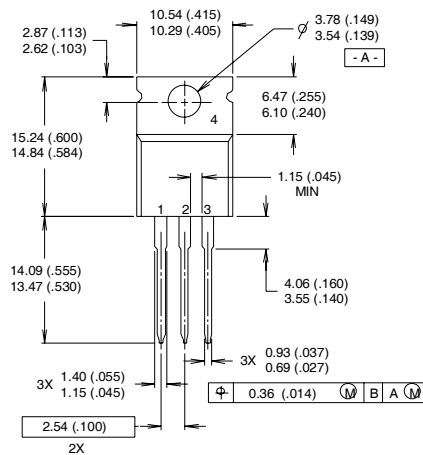

LEAD ASSIGNMENTS	
HEXFET	IGBTs, CoPACK
1- GATE	1- GATE
2- DRAIN	2- COLLECTOR
3- SOURCE	3- EMITTER
4- DRAIN	4- COLLECTOR

NOTES:

- 1 DIMENSIONING & TOLERANCING PER ANSI Y14.5M, 1982.
- 2 CONTROLLING DIMENSION : INCH

- 3 OUTLINE CONFORMS TO JEDEC OUTLINE TO-220AB.
- 4 HEATSINK & LEAD MEASUREMENTS DO NOT INCLUDE BURRS.

TO-220AB Part Marking Information

EXAMPLE: THIS IS AN IRF1010
 LOT CODE 1789
 ASSEMBLED ON WW 19, 1997
 IN THE ASSEMBLY LINE "C"
Note: "P" in assembly line position indicates "Lead-Free"

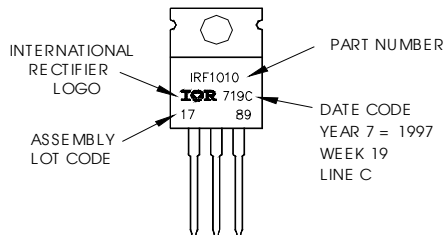

TO-220AB package is not recommended for Surface Mount Application

Data and specifications subject to change without notice.
 This product has been designed and qualified for Industrial market.
 Qualification Standards can be found on IR's Web site.



IR WORLD HEADQUARTERS: 233 Kansas St., El Segundo, California 90245, USA Tel: (310) 252-7105
 TAC Fax: (310) 252-7903

Visit us at www.irf.com for sales contact information. 08/04

www.irf.com

Note: For the most current drawings please refer to the IR website at:
<http://www.irf.com/package/>